

**Fitting Instructions:  
Scrambler  
Headlamp Grille Kit - A9758024**

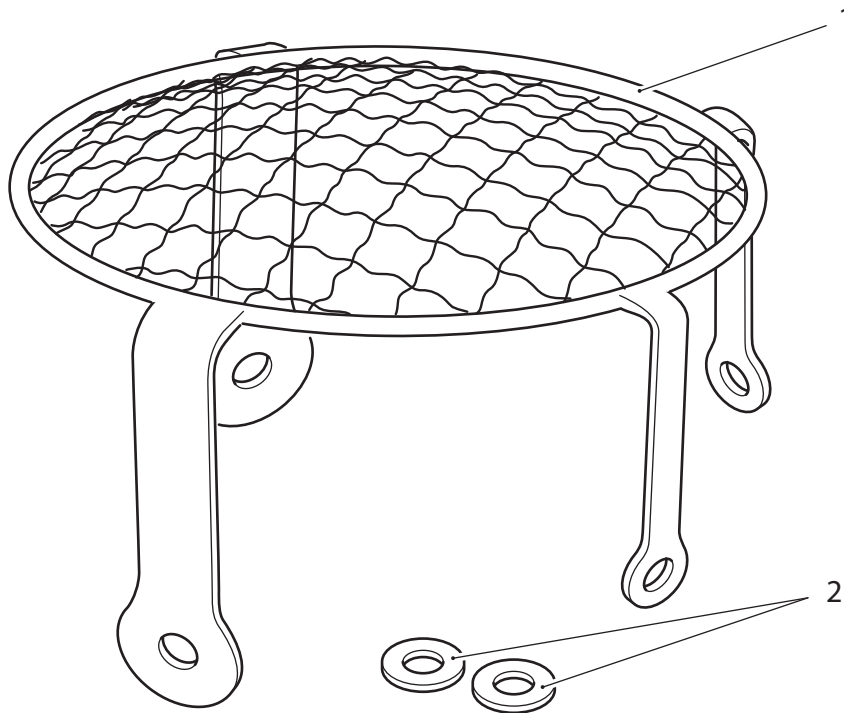

**Warning**

This accessory kit is intended exclusively for off-road use and should not be fitted to motorcycles destined for use on public roads. Use of a motorcycle fitted with this accessory kit on public roads may render the user liable to prosecution.



**Parts Supplied:**

- 1. Grille. . . . . 1 off
- 2. Spacer . . . . . 2 off

**Warning**

This accessory kit is designed for use on Triumph Scrambler motorcycles only and should not be fitted to any other Triumph model or to any other manufacturer's motorcycle. Fitting this accessory kit to any other Triumph model or to any other manufacturer's motorcycle, may interfere with the rider and could affect the stability and handling of the motorcycle leading to loss of control and an accident.

**Warning**

Always have Triumph approved parts, accessories and conversions fitted by a trained technician of an authorised Triumph dealer. The fitment of parts, accessories and conversions by a technician who is not of an authorised Triumph dealer may affect the handling, stability or other aspects of the motorcycles operation which may result in loss of motorcycle control and an accident.

**Warning**

Throughout this operation, ensure that the motorcycle is stabilised and adequately supported on a paddock stand to prevent risk of injury from the motorcycle falling.

## NOTE

- Completely read all the instructions before commencing the installation and set up of the headlamp grille kit in order to become thoroughly familiar with the kit's features and the installation process.

1. Remove the seat and disconnect the battery, negative (black) lead first.
2. Undo and remove the two fixings which secure the headlamp rim to the headlamp body.
3. Undo and remove the two headlamp mounting bolts and washers.

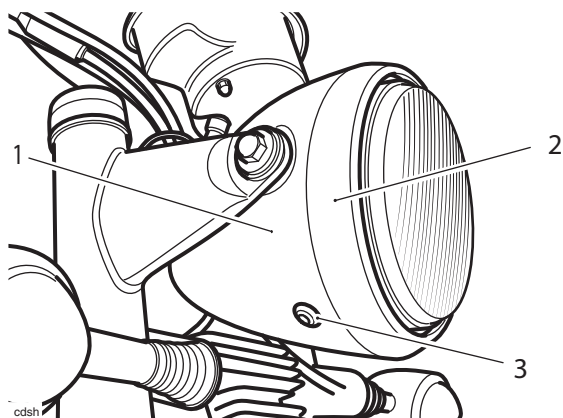

1. Headlamp body
2. Headlamp rim
3. Fixing (right-hand shown)

## NOTE

- Do not remove the headlamp rim.

 <b>Caution</b>
To help prevent damage to the headlamp rim, ensure that it does not become detached from the headlamp body.

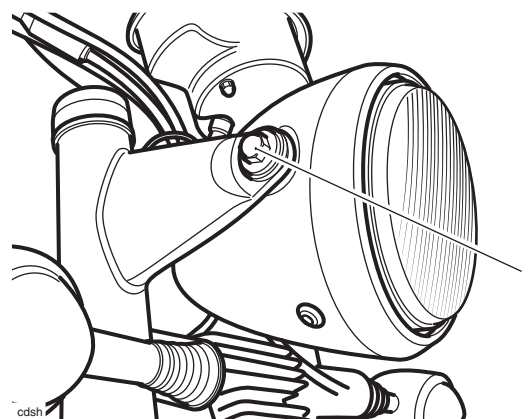

1. Headlamp mounting bolt (right-hand shown)

4. Position the grille over the headlamp as shown. Ensure that the longer arms of the grille are positioned to the outside of the headlamp brackets.

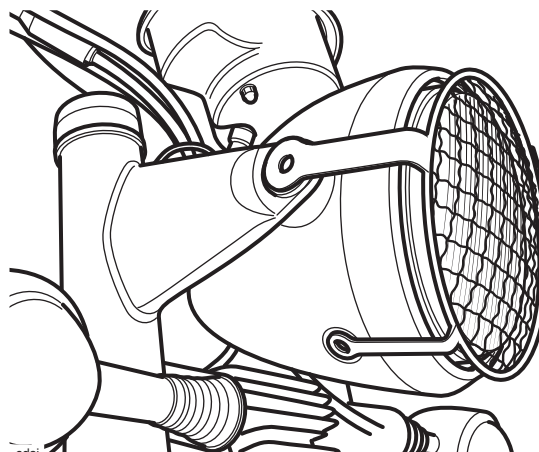

5. Loosely secure the grille and headlamp body to the headlamp brackets using the original screws and washers.

6. Place a spacer behind each of the shorter grille arms as shown.

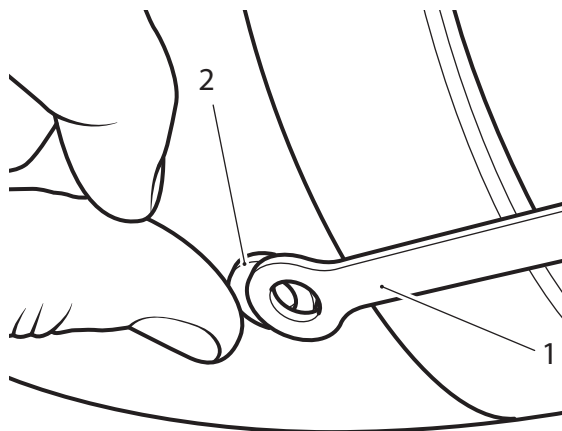

- 1. Short grille arm (right-hand shown)**  
**2. Spacer**

7. Secure the grille and the headlamp rim to the headlamp body using the original fixings. Tighten the fixings to **3 Nm**.
8. Reconnect the battery, positive (red) lead first.
9. Adjust the headlamp beam as follows:
- Switch the headlamp dipped beam on.
  - Vertical adjustment of the headlamp beam is made by slackening its mounting bolts and repositioning the light unit on its mounting brackets. Once the beam is correctly set retighten the mounting bolts to **10 Nm**.

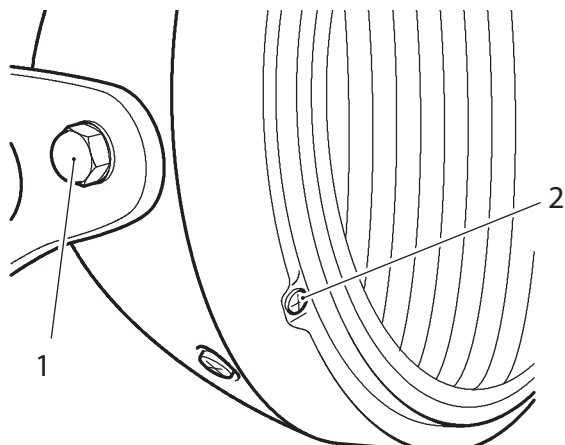

**Headlamp (grille not shown)**

- 1. Headlamp mounting bolt**  
**2. Horizontal adjustment screw**

- Horizontal adjustment of the beam is made using the screw in the headlight rim. Rotate the adjustment screw clockwise to move the beam to the left and anti-clockwise to move it to the right.
- Switch the headlight off when the beam is correctly set.

**! Warning**

With the headlamp grille fitted, the light output of the headlamp may be reduced. Operate the motorcycle in a safe area free from traffic to gain familiarity with the lighting characteristics of the accessorised headlamp. Operation of the motorcycle when not familiar with the lighting characteristics of an accessorised headlamp may result in loss of motorcycle control and an accident.

**! Warning**

Always adjust road speed to suit the visibility and weather conditions in which the motorcycle is being operated. Ensure that the beams are adjusted to illuminate the road surface sufficiently far ahead without dazzling oncoming traffic. An incorrectly adjusted headlamp may impair visibility causing an accident.

**! Warning**

Never attempt to adjust a headlamp beam when the motorcycle is in motion. Any attempt to adjust a headlamp beam when the motorcycle is in motion may result in loss of motorcycle control and an accident.

**! Warning**

If, after fitment of the accessory kit, there is any doubt as to any aspect of the performance of the motorcycle, contact an authorised Triumph dealer and do not ride the motorcycle until the authorised dealer has declared it fit for use. Riding a motorcycle when there is any doubt as to any aspect of the performance of the motorcycle may result in loss of control of the motorcycle and an accident.